

The Derby Steel™ 8 Seat Octagon Table (ADA Compliant)

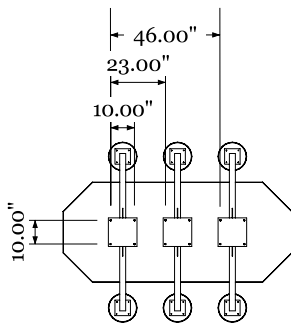

MOUNTING PLATE PATTERN DIMENSIONS

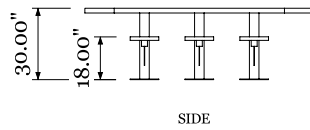

SIDE

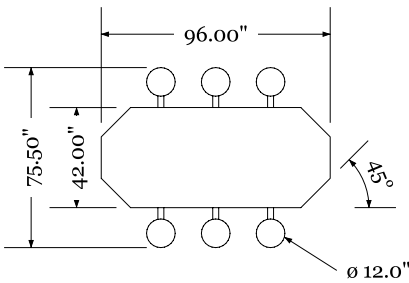

TOP

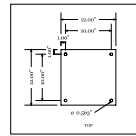

FLOOR MOUNT DETAIL

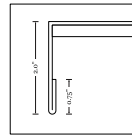
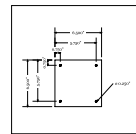
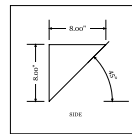

TABLE DROP EDGE DETAIL



MOUNTING PLATE DETAIL



BRACKET DETAIL

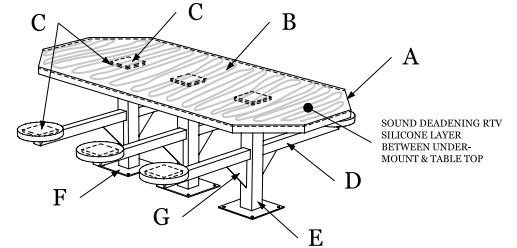
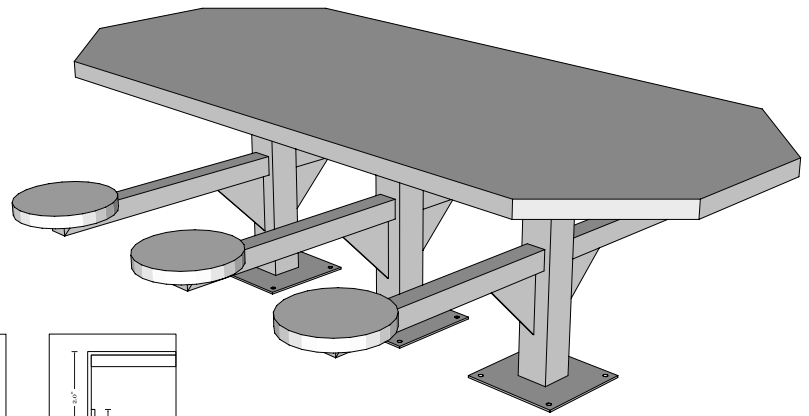

SOUND DEADENING RTV SILICONE LAYER BETWEEN UNDER-MOUNT & TABLE TOP

OVERVIEW

Heavy duty floor mounted steel table. For use in correctional facilities. ADA compliant table is wheelchair accessible.

FABRICATION

All welded construction. The base frame features three 4" steel pedestals welded at the top to 1/4" mounting plates for installing table top. Six 2 1/2" stool support arms are welded to the pedestals. A 1/4" steel under-mount plate is stitch welded to the under side of the table top. A layer of RTV silicone is applied between the table top and the under-mount plate to reduce noise and vibration. Three 1/4" threaded mounting plates are welded to the under-mount plate for fastening to the frame mounts with security screws. 12" diameter stainless steel stool seats with 1 1/2" drop edge with threaded mounting plates welded to the underside for securing to seat mounting plates. Steel 1/4" floor mounting plates with 9/16" diameter holes are provided for welding or bolting to the floor.

MATERIAL

- 42" x 42" 14 gauge stainless steel Type 304 2B finish octagon table top.
- 12" diameter stool seat tops with 1 1/2" drop edges and steel 1/4" threaded mounting plates welded to a 10 gauge under-mount.
- 2 1/2" & 4" standard box tubing support frame.
- Steel 1/4" frame mounting plates.
- Steel 1/4" under-mount table plate with two steel 1/4" threaded mounting plates welded on for securing to base frame mounting plates.

COLOR

Vitracoat T.K. Gray.

WEIGHT

TBD.

OPTIONS

Hemmed table top edges.

ASSEMBLY

Attach seat tops and table top to support base frame.

INSTALLATION

Bolt or weld to floor.*

WARRANTY

1 year limited replacement warranty.

MAINTENANCE

Easy clean up with a damp cloth and mild detergent.

*Floor and wall mounting hardware not included.

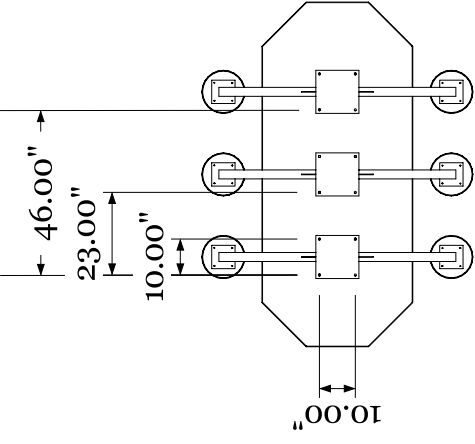

MOUNTING PLATE PATTERN DIMENSIONS

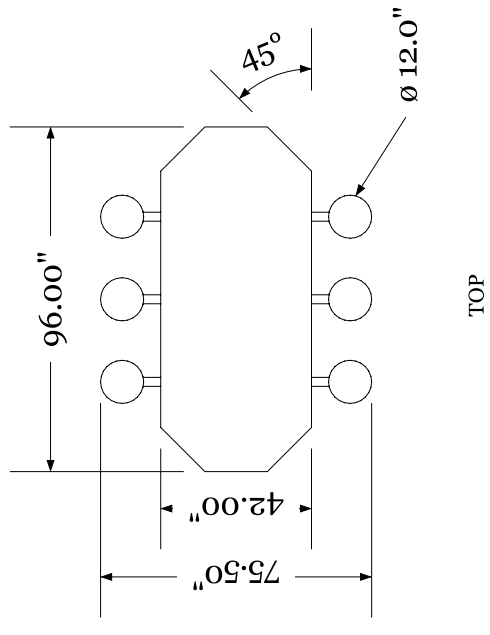

TOP

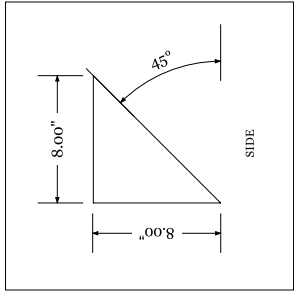

BRACKET DETAIL

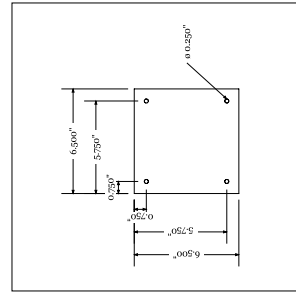

MOUNTING PLATE DETAIL

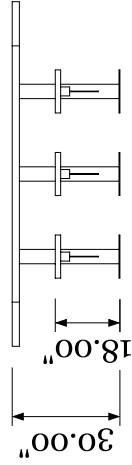

SIDE

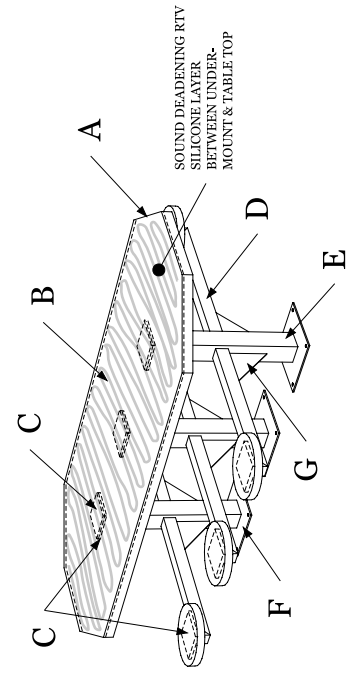

FLOOR MOUNT DETAIL

ITEM	DESCRIPTION	QTY
A	TABLE TOP, 304 STAINLESS STEEL, 14 G.	1
B	TABLE UNDER-MOUNT, SHEET METAL, 1/4"	1
C	MOUNTING PLATE, SHEET METAL, 1/4"	12
D	SUPPORT, 3" BOX TUBING, 14 G.	6
E	PEDESTAL, 4" BOX TUBING, 14 G.	3
F	FLOOR MOUNTING PLATE, SHEET METAL, 14 G.	3
G	SUPPORT BRACKET, SHEET METAL, 7 G.	6

STANDARD TOLERANCES .X = ±.12" .XX = ±.06" .XXX = ±.03" ANGLE = ± 1°



8 Seat Octagon Table (ADA Compliant)

REVISIONS		REMARKS
MM/DD/YY		
1	---	...
2	---	...
3	---	...
4	---	...
5	---	...