

DETAIL OF LADDER BRACE

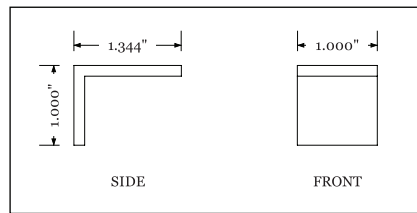

DETAIL OF LADDER HOOK

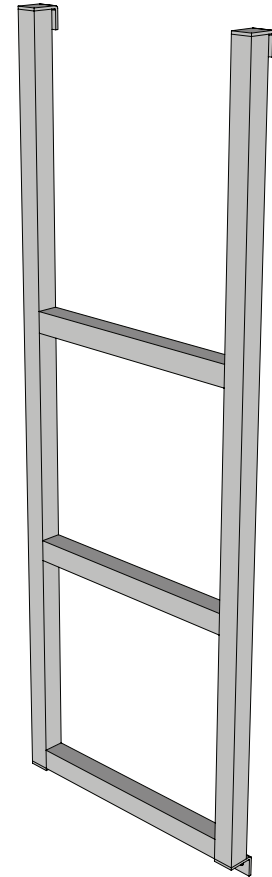

OVERVIEW

Heavy duty steel ladder intended for Derby bunks.

FABRICATION

All welded steel bunk ladder. All bunk ladders have a baked-on polyester powder coat semi-gloss finish.

MATERIAL

- 1" box tubing.
- 10 gauge hooks and braces.

COLOR

Vitracoat T.K. Gray.

WEIGHT

TBD

OPTIONS

- Prime coat.
- Custom sizes available.

ASSEMBLY

No assembly required.

INSTALLATION

N/A

WARRANTY

1 year limited replacement warranty.

MAINTENANCE

Easy clean up with a damp cloth and mild detergent.

*Floor and wall mounting hardware not included.

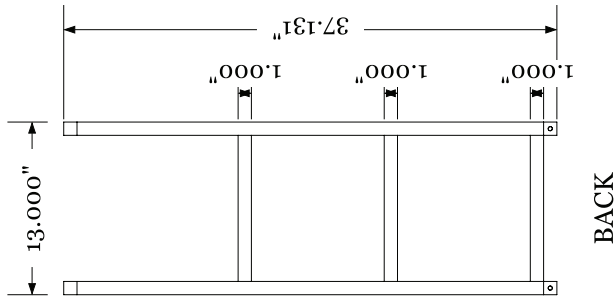

BACK

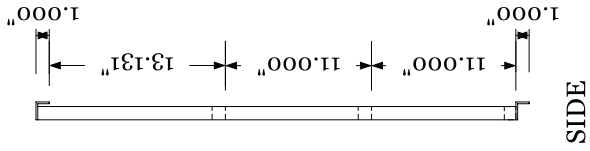

SIDE

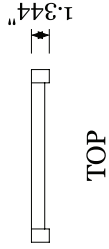

TOP

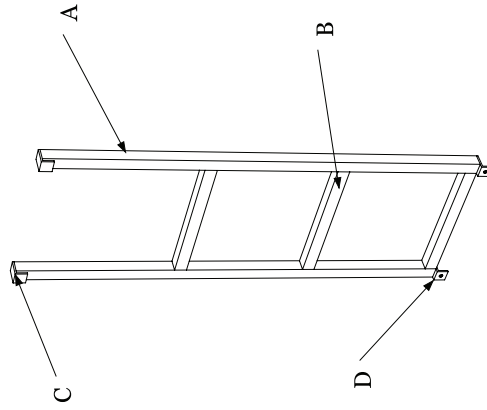

DETAIL OF LADDER ATTACHMENT

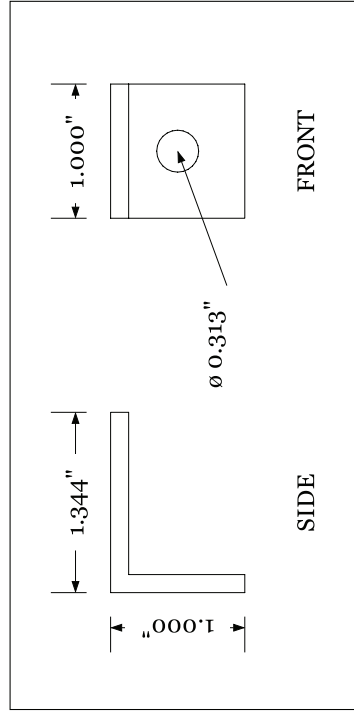
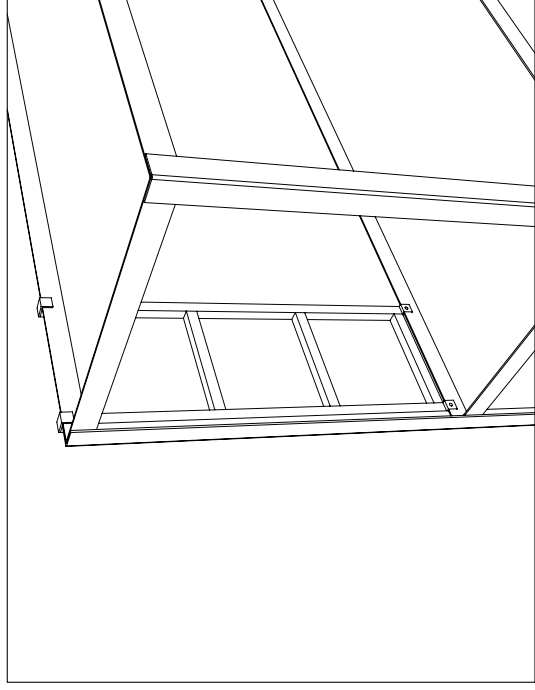

DETAIL OF LADDER BRACE

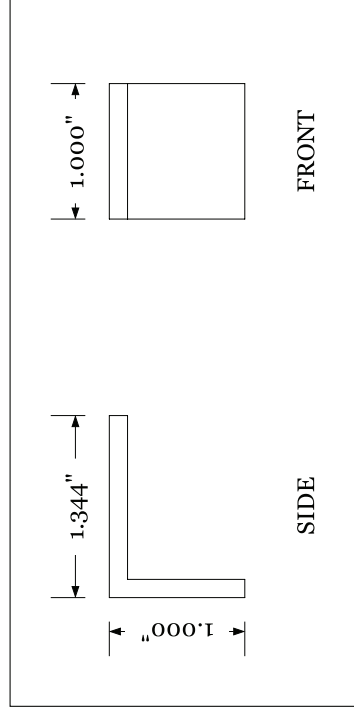

DETAIL OF LADDER HOOK

ITEM	DESCRIPTION	QTY
A	RAIL, 1" BOX TUBING, 1/8"	2
B	RUNG, 1" BOX TUBING, 1/8"	3
C	HOOK, SHEET METAL, 10 G. HRPO"	2
D	BRACE, SHEET METAL, 10 G. HRPO	2

STANDARD TOLERANCES
 .X = ±.12" .XX = ±.06" .XXX = ±.03" ANGLE = ± 1°



Optional Bunk Ladder

REVISIONS	
MM/DD/YY	REMARKS
1	...
2	...
3	...
4	...
5	...