

The Derby Steel™ Welded Wall Mount Desk Unit

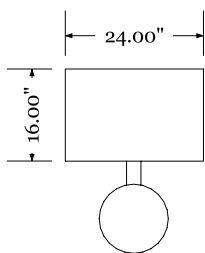

TOP

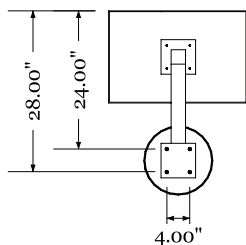

MOUNTING HOLE PATTERN DIMENSION

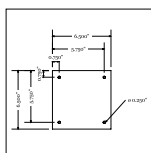

MOUNTING PLATE DETAIL

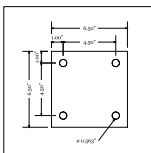

FLOOR MOUNT DETAIL

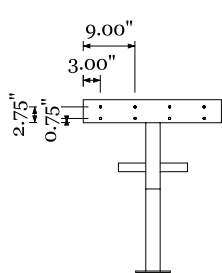

BACK

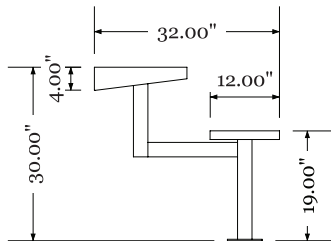

SIDE

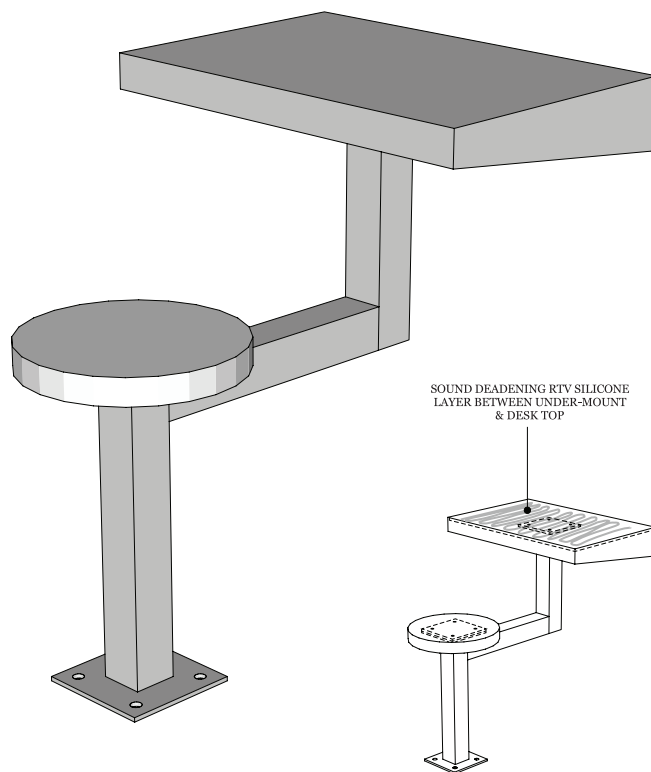

SOUND DEADENING RTV SILICONE LAYER BETWEEN UNDER-MOUNT & DESK TOP

OVERVIEW

Heavy duty wall mounted one-piece steel desk unit with stool. For use in institutional or correctional facilities.

FABRICATION

All welded construction. The base frame is manufactured from 2 1/2" steel box tubing welded at the top to a 1/4" mounting plate for attaching the frame to the desktop. The bottom of the stool pedestal has a welded floor mounting plate attached. The wall desk frame has a baked on polyester powder coat finish.

MATERIAL

- 16" x 24" 10 gauge steel desktop.
- 12" diameter 14 gauge 304 stainless stool seat top with a 1 1/2" drop edge.
- 2 1/2" standard box tube desk support frame.
- Steel 1/4" floor mounting plate with 9/16" diameter holes are provided for welding or bolting to the floor.
- Steel 1/4" frame mounting plate welded to the 1/4" desk under-mount.

COLOR

Vitracoat T.K. Gray.

WEIGHT

TBD

OPTIONS

- 14 gauge stainless steel desktop Type 304 2B Finish.
- Prime coat.

ASSEMBLY

No assembly required.

INSTALLATION

Bolt unit to wall and floor.*

WARRANTY

1 year limited replacement warranty.

MAINTENANCE

Easy clean up with a damp cloth and mild detergent.

*Floor and wall mounting hardware not included.

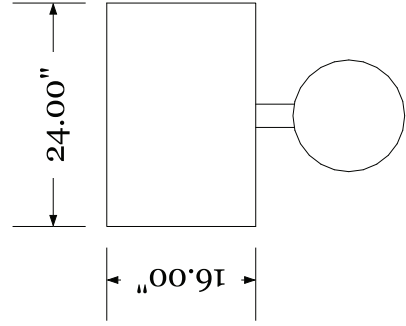

TOP

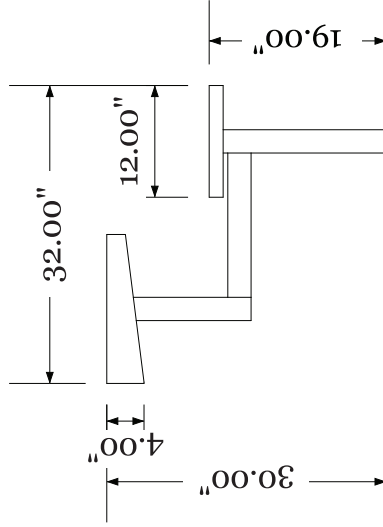

SIDE

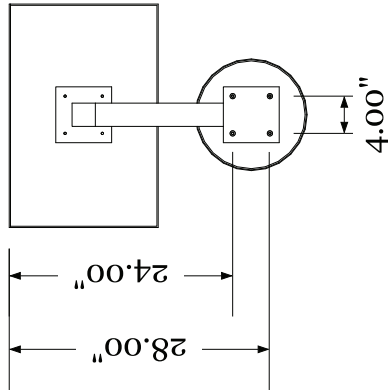

MOUNTING HOLE PATTERN DIMENSION

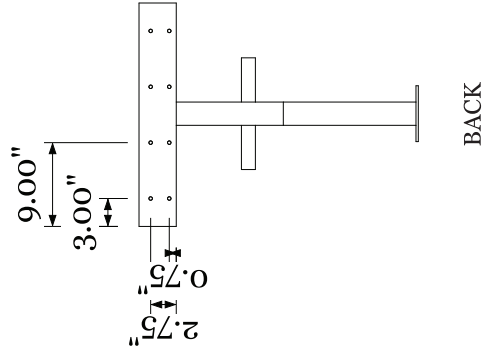

BACK

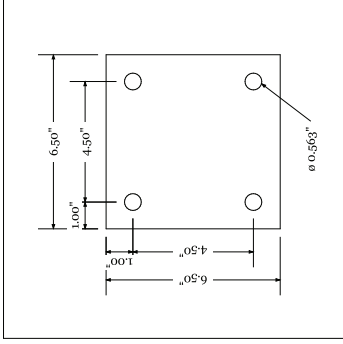

FLOOR MOUNT DETAIL

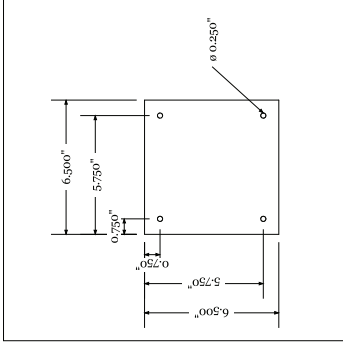

MOUNTING PLATE DETAIL

SOUND DEADENING RTV SILICONE LAYER BETWEEN UNDER-MOUNT & DESK TOP

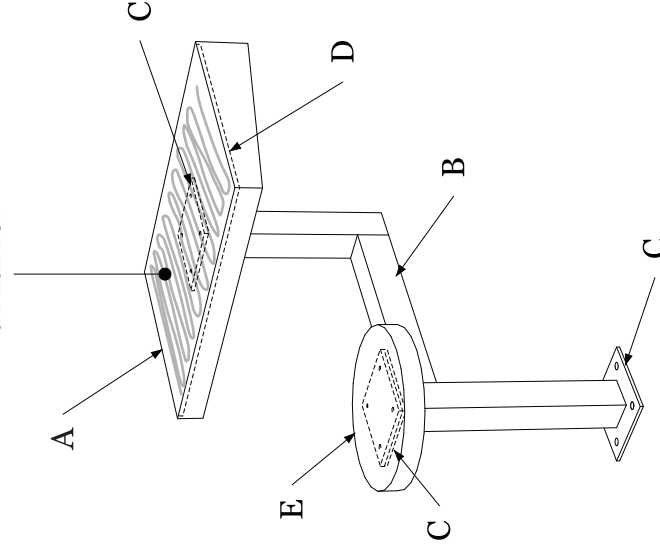

ITEM	DESCRIPTION	QTY
A	DESK TOP, SHEET METAL, 10 G.	1
B	SUPPORT FRAME, 2 1/2" BOX TUBING, 14 G.	3
C	MOUNTING PLATE, SHEET METAL, 1/4"	3
D	UNDER-MOUNT, SHEET METAL, 1/4"	1
E	STOOL TOP, 304 STAINLESS STEEL, TBD	1

STANDARD TOLERANCES
 .X = ±.12" .XX = ±.06" .XXX = ±.03" ANGLE = ± 1°

DERBY INDUSTRIES

Wall Desk Unit (Welded) Version 1

MM/DD/YY	REVISIONS	REMARKS
1	1	...
2	2	...
3	3	...
4	4	...
5	5	...